

KEY FEATURES

- Universal input voltage range (85 – 264 V_{AC})
- Active PFC, EN 61000-3-2 compliant
- Input surge current limiting (<20A)
- High power density (23W/in³)
- Steady 600W output power available in a 3x5x1.6" form factor
- Fan speed control function for quiet operation
- Four (4) slots configurable for up to eight (8) outputs
- Output modules series and parallel operation
- Accurate wired current share among paralleled modules
- Remote output voltage programming / control
- Remote output current programming / control
- Output current monitoring signal
- +/- sense terminal for each slot
- Output modules +5V, 10mA bias supply
- Remote single slot or simultaneous inhibit signals
- Power chassis +5V, 200mA bias supply
- AC good signal
- Power good signal for each slot
- Over temperature, OV, OC and SC protections
- EN55011, EN55032 Class B, conducted radiated emissions.
- RoHS 2 compliant (Directive 2011/65/EU)



DESCRIPTION

The RCB600 series of modular and configurable AC-DC power supplies provides high performance and wide flexibility in an extremely compact package. The series is capable of a steady 600W from a 3 X 5 X 1.6" package, distributed among four independent and isolated slots where any of the six available output modules may be plugged.

The output modules are rated for 150W and are available in single nominal output voltages of 5, 12, 24 and 48V, and two double nominal output voltages of 12 and 24V. Thanks to their extremely wide output voltage adjustability range and the possibility to connect modules of the same type in series and parallel, the RCB600 offers an unrivalled flexibility.

Advanced functions such as remote output current / voltage control and programming, single slot inhibit and all slots inhibit make the RCB600 interactive with complex industrial and automation systems.

Other available signals include power supply AC-Good and output modules Power-Good and +/- Sense Terminals.

The RCB600 comes in a closed package with a built-in speed-controlled fan to ensure the required airflow while maintaining minimal operational noise, which ultimately enhances the power supply service life time.

Output modules of the same type can be connected in parallel in any number in the same chassis without any OR-ing protection. Paralleling modules across multiple chassis does require OR-ing protection with FET or Diodes. This is also true when operating modules in a N+1 redundant configuration.

Protection features include a fuse on AC lines, input under voltage lockout (IUV), output over-current (OC), output short-circuit (SC), output over-voltage (OV) and over-temperature (OT).

The RCB600 series complies with the 2nd edition of the IEC/EN/UL/CSA 60950-1 safety standard for IT equipment. It also complies with the Class B limits of the standards EN55011, EN55032 for conducted and radiated emissions, IEC/EN 61000-3 Class A for harmonic content and IEC/EN 61000-4 for EMC immunity.

MARKET SEGMENTS AND APPLICATIONS

- Industrial Process Control and Automation
- Telecommunications
- Laboratory / Analysis Equipment
- Test and Measurement Equipment

MODEL CODING AND OUTPUT AND RATINGS

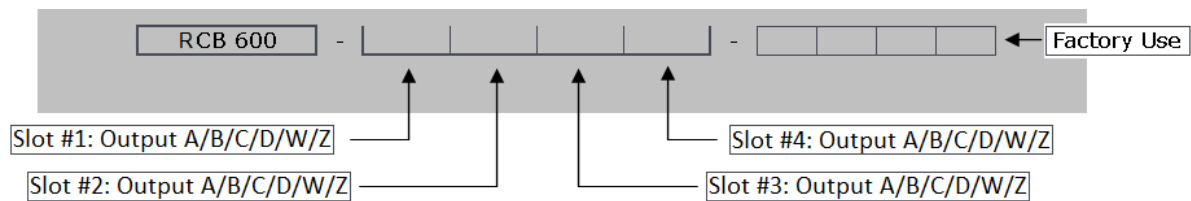

Use "0" for unused slots. A slot cover bracket will be fitted at factory

The factory might issue a 4 digit code for a specific configuration which can be used for next and future orders of the same configuration
 When ordering an input unit with no output inserted, simply order "RCB600"

Output Module	Nominal Voltage	Voltage Adjustment	Output Rated Power	Rated Current	Max Current at Nom Voltage	Load Regulation	Over Voltage trip level
A	5 V	1.5 to 7.5 V	125 W	25.0 A	25 A	±50 mV	9.5 V
B	12 V	4.5 to 15 V	150 W	15.0 A	12.5 A	±100 mV	18 V
C	24 V	9 to 30 V	150 W	7.5 A	6.25 A	±150 mV	36 V
D	48 V	18 to 58 V	150 W	3.75 A	3.13 A	±300 mV	66 V
W	2x 12 V	3.3 to 15 V	2x 75 W	5.0 A	5.0 A	±50 mV	20 V
Z	2x 24 V	15 to 38 V	2x 75 W	3.125 A	3.125 A	±150 mV	44 V
0 (Zero)		Metal blanking plate for unused slots.					

INPUT SPECIFICATIONS

Parameter	Details	Min	Typ	Max	Units
AC input voltage	Nominal range is 100 to 240 V _{RMS}	85		264	V _{RMS}
AC input frequency		47	50/60	63	Hz
DC input voltage		120		300	V _{DC}
Power rating	De-rate by 0.83%/V _{RMS} below 120 V _{RMS} (600 W at 120 V _{RMS} , 450 W at 90 V _{RMS})			600	W
Input current	At 600 W output and 120 V _{RMS} input			6	A
Inrush current	265 V _{RMS} , cold start			20	A
Fusing	5x20 fast acting fuse			8	A
Input current limit	Maintains power factor		8		A
Efficiency	Configuration dependent		86	89	%
Idle power	All outputs fitted and enabled All outputs fitted and disabled		28 21		W
Power factor	Typical value at 300 W output at 240 V _{RMS}		0.96	0.99	
Hold up	600 W output at 120 V _{RMS} input	17	20	21	ms
UVLO	Turn on only	78		84	V _{RMS}
Over temperature	Internally monitored. Latching	115		125	°C
Reliability	At 40 °C, 80% load			2	FPMH

SIGNALS / CONTROLS AND TIMING

Parameter	Details	Min	Typ	Max	Units
Bias voltage		4.8	5	5.2	V
Bias current		0		200	mA
Power Good Voltage	PNP open collector with internal 10 kΩ pull down resistor	8	10	15	V
Power Good Current		0		20	mA
Individual inhibit voltage	Apply ≥ 5 V when used as Global Inhibit	2		15	V
Inhibit current	10 kΩ input impedance	0.2		1.5	mA
Global inhibit voltage		3		15	V
Global inhibit current	5 kΩ input impedance	0.6		3	mA
AC_OK voltage		1		4	V
AC_OK current		-10		20	mA
AC_OK warning	See user manual for exceptions	5			ms

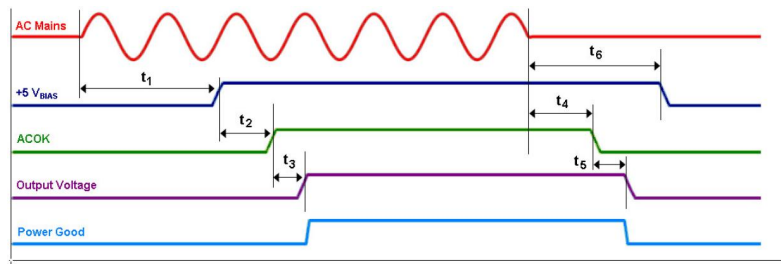

AC Mains asserted – +5VBIAS supply effective:	t1 = 300 ms	AC Mains de-asserted – ACOK signal Off:	t4 = 15 ms
AC Mains asserted – ACOK signal On:	t1 + t2 = 350 ms	AC Mains de-asserted – Power-Good low:	t4 + t5 = 20 ms
AC Mains asserted – Power-Good high:	t1 + t2 + t3 = 325 ms	AC Mains de-asserted – +5VBIAS supply Off:	t6 = 100 ms

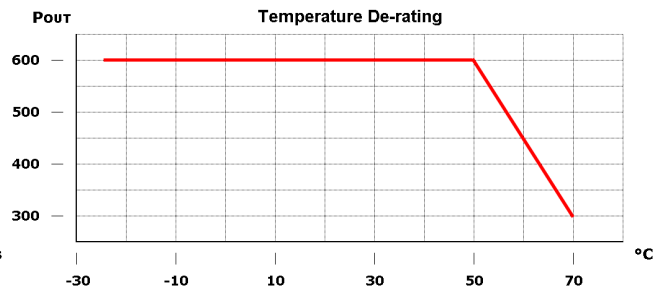
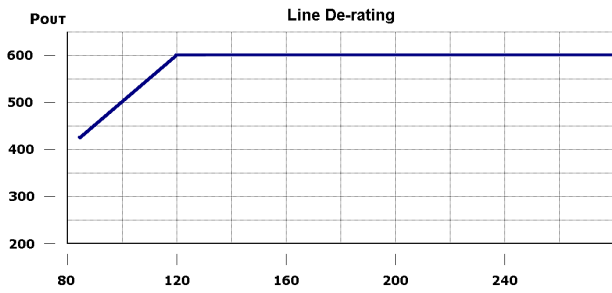

ENVIRONMENTAL, INSTALLATION AND RELIABILITY

Parameter	Details	Min	Max	Units
Storage				
Temperature		-40	+85	°C
Humidity	Relative, non-condensing	5	95	%
Altitude		-200	5000	m
Air Pressure		54	106	kPa
Operating				
Temperature	Full power De-rating input and output at 2.5% / °C	-20	50	°C
Humidity	Relative, non-condensing	5	95	%
Altitude		-200	4600	m
Air Pressure		69	106	kPa
Acoustic Noise	Variable to input voltage, ambient temperature, load Measured at 1 m from fan intake	35	60	dB(A)
Shock	3000 bumps at 10 g (16 ms) half sine wave			
Vibration	1.5 g, 10 to 200 Hz sine wave, 20 g for 15 min in three axes random vibration			
Installation				
Equipment Class	I			
Installation Category	Category II			
Pollution Degree	2			
Material Group	IIIb (indoor use only)			
Flammability Rating	94V-2			
IP Rating	IP10			
RoHS Compliance	Directive 2011/65/UE			
Reliability				
Fan	Mag Lev Std		2.7	FPMH
Power unit	Input + Transformer modules excluding fan		2	FPMH
Output Modules	See individual output data-sheets		1	FPMH
Warranty			2	Years

INPUT VOLTAGE AND TEMPERATURE DE-RATING

ELECTROMAGNETIC COMPATIBILITY (EMC) – EMISSIONS

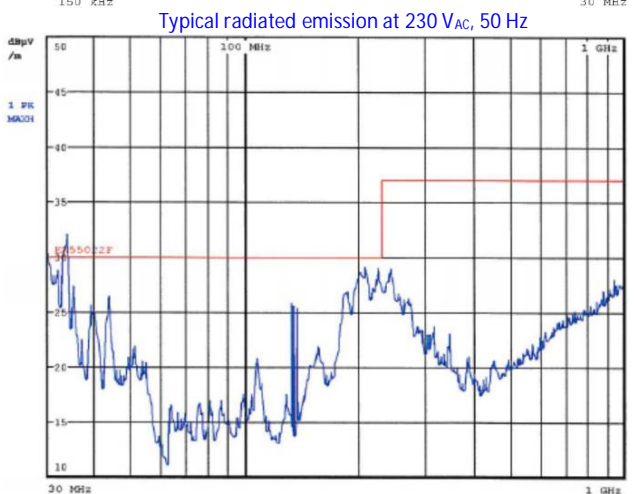
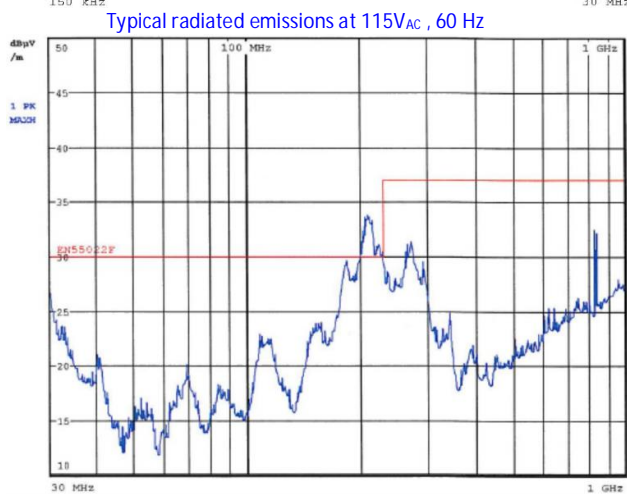
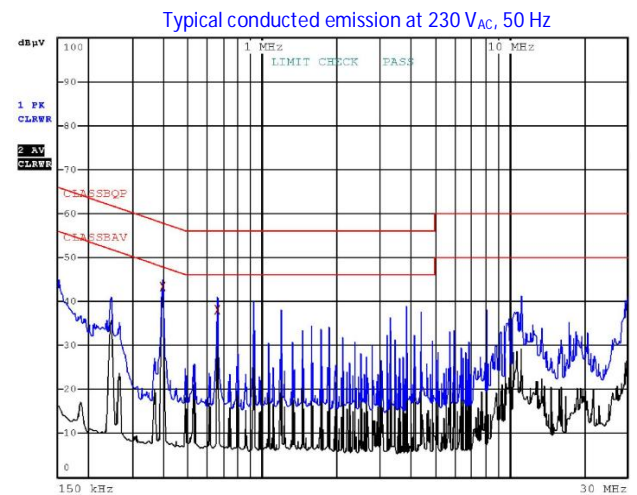
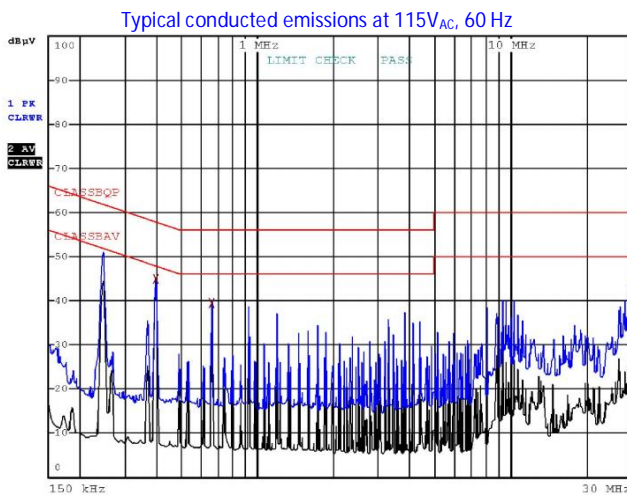
Phenomenon	Conditions / Notes	Standard	Equipment/Performance Class
Conducted	115, 230 V _{AC} at maximum load	EN 55032 (ITE) EN 55011 (ISM)	B
Radiated	115, 230 V _{AC} at 10 m distance	EN 55032 (ITE) EN 55011 (ISM)	B
Line Voltage Fluctuation and Flicker		EN 61000-3-3	Compliant
Harmonic Current Emission	230 V _{AC} , 50 / 60 Hz	EN 61000-3-2	Class A Compliant



ELECTROMAGNETIC COMPATIBILITY (EMC) – IMMUNITY

Phenomenon	Conditions / Notes	Standard	Test Level	Criteria
	Reference standards for ITE	EN 55024		
	Reference standard for Industrial/IMS equipment	EN 61000-6-2		
ESD	15 kV air discharge, 8 kV contact discharge, at any point of the system.	EN 61000-4-2	4	A
Radiated Field	10 V/m, 80-2700 MHz, 1 KHz/2 Hz 80% AM.	EN 61000-4-3	3	A
Electric Fast Transient	±4 kV on AC power port for 1 minute	EN 61000-4-4	3	A
Surge	±1 kV line to line; ±2 kV lines to earth on AC power port	EN 61000-4-5	4	A
Conducted RF Immunity	10 V _{RMS} , 0,15-80 MHz, 1 kHz/2 Hz 80% AM.	EN 61000-4-6	3	A
Dips and Interruptions	230 V _{AC} :			
	Drop-out to 0% for 10 ms	EN61000-4-11		A
	Dip to 40% for 5 cycles (100 ms)	EN61000-4-11		A
	Dip to 70% for 25 cycles (500 ms)	EN61000-4-11		A
	Drop-out to 0% for 2 s	EN61000-4-11		B
	115 V _{AC} :			
	Drop-out to 0% for 10 ms	EN 61000-4-11		A
	Dip to 40% for 5 cycles (100 ms)	EN 61000-4-11		A
	Dip to 70% for 25 cycles (500 ms)	EN 61000-4-11		A
	Drop-out to 0% for 2 s	EN 61000-4-11		B

SAFETY PARAMETERS

Parameter	Details	Min	Max	Units
Isolation Voltage	Primary to Secondary	4000		V _{RMS}
	Primary to Protection Earth (chassis)	1500		V _{RMS}
	Output to Chassis isolation is guaranteed up to 250 V _{DC}			
	Output to Outputs isolation is guaranteed up to 250 V _{DC}			
Isolation Clearance	Primary to Secondary	7		mm
	Primary to Chassis	2.5		mm
Isolation Creepage	Primary to Secondary	12		mm
	Primary to Chassis	4		mm
Earth Leakage Current	265 V _{AC} , 63 Hz, 25 °C ambient		300	µA

SAFETY AGENCIES APPROVALS

Certification Body	Safety Standards and file numbers	Category
CSA/UL	CSA C22.2 No. 60950-1, UL 60950-1; 2007, 2 nd edition +A1 + A2 UL: E134098-A35-CB-2	Information Technology Equipment
IEC IECCE CB Certification Demko	IEC/EN 60950-1 2 nd edition + A1 + A2 CB Certificate: DK-49554-UL Demko Certificate: D-04652	Information Technology Equipment
CE	Directive 2014/35/EU: Electrical Safety: Low Voltage electrical equipment (LVD) Directive 2014/30/EU: Electromagnetic Compatibility (EMC) Directive 2011/65/EU: RoHS 2	Information Technology Equipment
Designed to meet IEC/EN/UL/CSA 61010-1 2 nd edition		

MECHANICAL SPECIFICATIONS – OUTLINE DRAWING AND DIMENSIONS

Specification	Details	Nominal	Units
Dimensions	Height is 1U	77.7 x 136.25 x 41.0	mm
		3.06 x 5.36 x 1.61	in
Weight	Chassis + input	360	g
	Output modules	60	g
	Chassis + input	0.794	lb
	Output modules	0.132	lb
Mounting	Bottom or side mounting through M4 screws	M4	

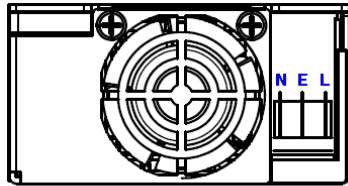

N - Neutral
 E - Earth
 L - Live

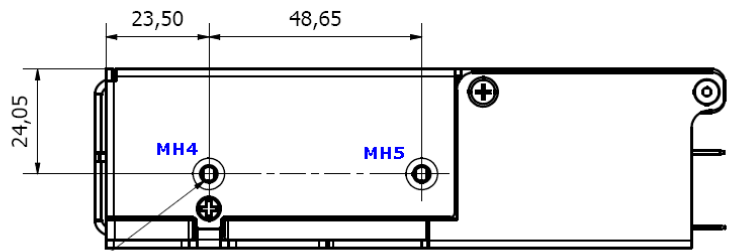
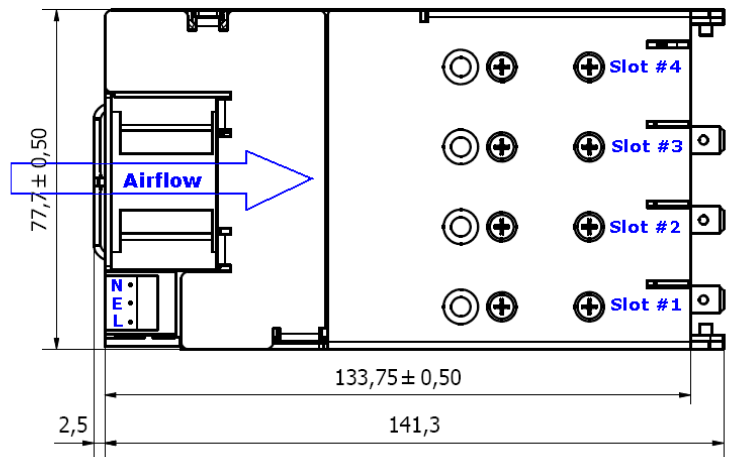
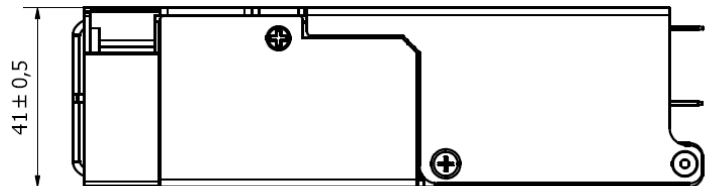

M4 (2x) ∇ 4 mm (max)

M4 (3x) ∇ 4 mm (max)

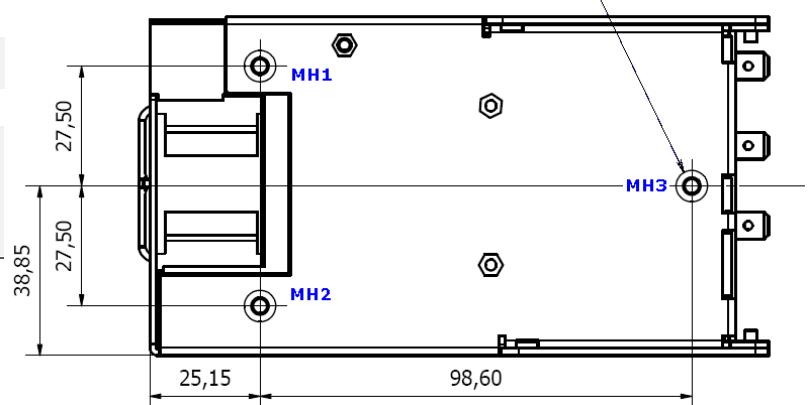

SCREWS	
Power Chassis MH1, MH2, MH3, MH4, MH5	
Screw type	M4
Tightening torque	Tighten to 0.55 Nm (4.87 lb-in) (*)
Penetration depth	4.00 mm max, including chassis
Output Modules x 8	
Screw type	M3x4, C/Sink, Posi, Stainless steel
Tightening torque	Tighten to 0.36 Nm (3.19 lb-in) (*)
Penetration depth	Defined by screw
Secondary cover x 2	
Screw type	M3x4, C/Sink, Posi, Stainless steel
Tightening torque	Tighten to 0.36 Nm (3.19 lb-in) (*)
Penetration depth	Defined by screw
Primary Cover x 2	
Screw type	M2.5x4, C/Sink, Posi, Stainless steel
Tightening torque	Tighten to 0.36 Nm (3.19 lb-in) (*)
Penetration depth	Defined by screw
Fan x 2	
Screw type	M3x30, C/Sink, Posi, Stainless steel
Tightening torque	Tighten to 0.36 Nm (3.19 lb-in) (*)
Penetration depth	Defined by screw

(*) Indicated tightening torque is the one recommended by the threaded insert manufacturer and it shall be regarded as a reference only. Over tightening the mounting screws may result in damaged threads.

MECHANICAL SPECIFICATIONS – INPUT / OUTPUT CONNECTIONS

PIN ASSIGNMENT	
Circuit	Details
J1	
1	Neutral
2	Earth
3	Live
J2	
1	Power Good Slot #1
2	Inhibit Slot #1
3	Power Good Slot #2
4	Inhibit Slot #2
5	Power Good Slot #3
6	Inhibit Slot #3
7	Power Good Slot #4
8	Inhibit Slot #4
9	Global Inhibit
10	AC OK
11	+5V 200mA, Bias Supply
12	COM
J5	
1	-Sense
2	+Sense
3	Voltage Control
4	Current Control
5	Current Sharing
6	Current Monitor
7	COM
8	+5V 10mA, Bias Supply
J3	
Positive Output	
J4	
Negative Output	

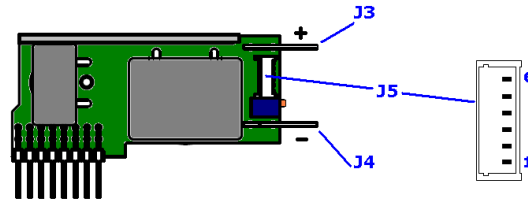
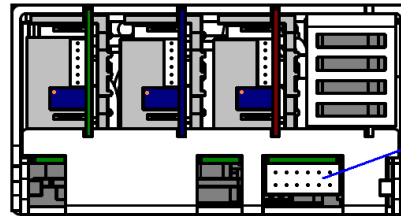
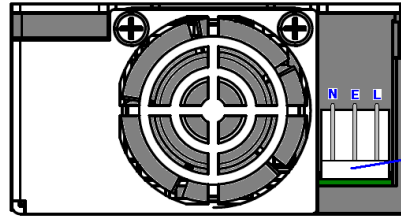
COUNTERPART CONNECTORS

Reference	Details	Manufacturer	Housing PN	Terminal PN
AC Mains Input J1	<ul style="list-style-type: none"> 5.08 mm (0.200 in), 3 circuits housing, with friction lock, or, any direct equivalent. Crimp terminal, 18-24 AWG, tin finish, or, any direct equivalent. 	Molex	0010013036	0008701031
Power Unit Signal J2	<ul style="list-style-type: none"> 2.00 mm (0.079 in) 12 circuits housing with locking ramp, or, any direct equivalent. Crimp terminal 24-30 AWG, gold finish, or, any direct equivalent. 	Molex	0511101260	0503948051
Output Power J3/J4	<ul style="list-style-type: none"> Quick Disconnect Receptacle compatible with PCB mounting TAB, size 0.80X6.35 mm. Tin finish. 	Vogt AG Tyco Electronics	NA	3967 640907-1
Output Signal J5	<ul style="list-style-type: none"> 1.25 mm (0.049 in), 6 circuits housing, Crimp terminal 28-32 AWG, tin finish, or, any direct equivalent 	Molex	0510210600	0500588000

Notes:

- Output power terminal and wire current rating must exceed maximum short circuit output current (OP-A: $25 \times 1.25 = 31.25$ A)
- Direct equivalents may be used for any connectors parts
- All cables must be rated 105°C min, equivalent to UL1015.

Dual Output Modules – OPW / OPZ – Pin Assignment and Outline drawing

Circuit	Description
V1 and V2 Output Voltages	
MOLEX 0430450400	
1	-V1
2	-V2
3	+V1
4	+V2
Signals	
MOLEX 0530480510	
1	S ⁻ (V2)
2	S ⁺ (V2)
3	Not connected
4	S ⁻ (V1)
5	S ⁺ (V1)

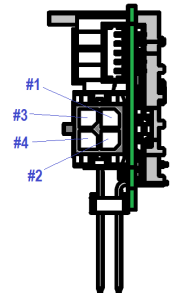
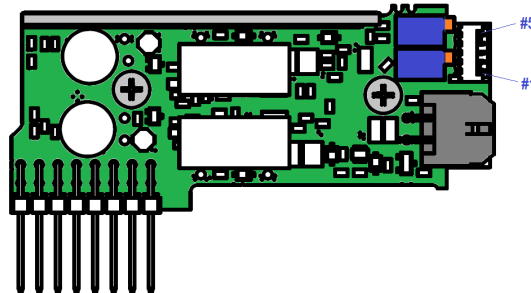
OPW / OPZ Counterpart Connectors

Reference	Details	Manufacturer	Housing PN	Crimp Terminal PN
V1 /V2 Outputs	<ul style="list-style-type: none"> Micro-Fit 3.0™ Receptacle Housing, Dual Row, 4 Circuits, Halogen Free. Micro-Fit 3.0™ Crimp Terminal, Female, with Tin (Sn) Plated Phosphor Bronze Contact, 20-24 AWG 	Molex	0430250400	43030-0001
Signals	<ul style="list-style-type: none"> 1.25mm Pitch PicoBlade™ Wire-to-Wire and Wire-to-Board Housing, Female, 5 Circuits. 1.25mm Pitch PicoBlade™ Crimp Terminal, Female, 28-32 AWG. 	Molex	51021-0500	50058-8000

OUTPUT SPECIFICATIONS – MODULE A (RCA-OPA)

Parameter	Test conditions / Notes	Min	Nominal	Max	Units
Output voltage range		1.5	5	7.5	V
Rated current				25	A
Average output power				125	W
Peak output power	<5 s, 50% duty cycle			187.5	W
Initial voltage accuracy	Factory set units, Measured at sense terminals	-0.5		0.5	% V _{SET}
Output voltage adjustment	Manual: 11-turns potentiometer		0.545		V/turn
Load regulation	Measured at sense terminals	-50		50	mV
Line regulation	Measured at sense terminals	-0.1		0.1	%V _{NOM}
Cross regulation	Measured at sense terminals	-0.2		0.2	%V _{NOM}
Minimum load			0		A
Output temperature drift		-0.02		0.02	%/°C
Ripple and Noise	20 MHz bandwidth, peak-peak			1	%V _{NOM}
Transient response	25% to 75% load transient, at 1A/μs, recovery to within 10% of V _{SET}			100	μs
Turn on rise time	Monotonic, 10% to 90%	1.5		3.5	ms
Turn on overshoot				0.1	%V _{SET}
Turn on delay	From AC on to Power Good From Enable to Power Good		600 15	750 20	ms ms
Current sharing accuracy				5	%I _{MAX}
Open sense offset	Open sense, voltage offset due to bias currents			2	%V _{NOM}
Hold-up voltage				6	V
Isolation to ground	Each terminal			250	V
Over current protection	% of rated current	105		125	%I _{RATED}
Reverse current protection	% of rated current	-6		0	%I _{RATED}
Short circuit protection (Hiccup mode)	Period Duty cycle Voltage threshold (at sense)		125 3 1		ms % V
Over voltage protection	Latching		9.5		V
Over temperature protection	Internally monitored, latching	115		125	°C
Sense cable protection	On positive terminal On negative terminal	-1 none		2 1	V V
Power good threshold	Low threshold only		90		%V _{SET}
Output current signal	I _{SGN} = 0.6 + I _{OUT} / (I _{RTD} * 1.25)	0		110	%I _{RATED}
Current limit control	I _{LMT} = (V _{CTRL} - 0.6) * I _{RTD} * 1.25	0		110	%I _{RATED}
Remote voltage control	V _{OUT} = V _{SET} ((1.8 - V _{CTRL}) / 0.6)	0		300	%V _{SET}
Bias supply	10 mA max	4.5	5	5.2	V
Reliability	At 40 °C, 80% load			1	FPMH
Warranty				2	Years
Wire size	Power cables	12	10		AWG
Weight				60	g
Size	60 mm x 35 mm x 17 mm, or, 2.36 in x 1.38 in x 0.67 in				

OUTPUT SPECIFICATIONS – MODULE B (RCA-OPB)

Parameter	Test conditions / Notes	Min	Nominal	Max	Units
Output voltage range		4.5	12	15	V
Rated current				15	A
Average output power				150	W
Peak output power	<5 s, 50% duty cycle			225	W
Initial voltage accuracy	Factory set units, Measured at sense terminals	-0.5		0.5	% V _{SET}
Output voltage adjustment	Manual: 11-turns potentiometer		0.954		V/turn
Load regulation	Measured at sense terminals	-100		100	mV
Line regulation	Measured at sense terminals	-0.1		0.1	%V _{NOM}
Cross regulation	Measured at sense terminals	-0.2		0.2	%V _{NOM}
Minimum load			0		A
Output temperature drift		-0.02		0.02	%/°C
Ripple and Noise	20 MHz bandwidth, peak-peak			1	%V _{NOM}
Transient response	25% to 75% load transient, at 0.5A/μs; recovery to within 10% of V _{SET}			1.5	V
				100	μs
Turn on rise time	Monotonic, 10% to 90%	1.5		3.5	ms
Turn on overshoot				0.1	%V _{SET}
Turn on delay	From AC on to Power Good		600	750	ms
	From Enable to Power Good		15	20	ms
Current sharing accuracy				5	%I _{MAX}
Open sense offset	Open sense, voltage offset due to bias currents			2	%V _{NOM}
Hold-up voltage				12.5	V
Isolation to ground	Each terminal			250	V
Over current protection	% of rated current	105		125	%I _{RATED}
Reverse current protection	% of rated current	-6		0	%I _{RATED}
Short circuit protection (Hiccup mode)	Period		125		ms
	Duty cycle		3		%
	Voltage threshold (at sense)		2		V
Over voltage protection	Latching		18		V
Over temperature protection	Internally monitored, latching	115		125	°C
Sense cable protection	On positive terminal	-1		2	V
	On negative terminal	none		1	V
Power good threshold	Low threshold only		90		%V _{NOM}
Output current signal	$I_{SGN} = 0.6 + I_{OUT}/(I_{RTD} * 1.25)$	0		110	%I _{RATED}
Current limit control	$I_{LMT} = (V_{CTRL} - 0.6) * I_{RTD} * 1.25$	0		110	%I _{RATED}
Remote voltage control	$V_{OUT} = V_{SET} ((1.8 - V_{CTRL}) / 0.6)$	0		300	%V _{SET}
Bias supply	10 mA maximum	4.5	5	5.2	V
Reliability	At 40 °C, 80% load			1	FPMH
Warranty				2	Years
Wire size	Power cables	16	14	10	AWG
Weight				60	g
Size	60 mm x 35 mm x 17 mm, or, 2.36 in x 1.38 in x 0.67 in				

OUTPUT SPECIFICATIONS – MODULE C (RCA-OPC)

Parameter	Test conditions / Notes	Min	Nominal	Max	Units
Output voltage range		9	24	30	V
Rated current				7.5	A
Average output power				150	W
Peak output power	<5 s, 50% duty cycle			225	W
Initial voltage accuracy	Factory set units, Measured at sense terminals	-0.5		0.5	% V _{SET}
Output voltage adjustment	Manual: 11-turns potentiometer		1.9		V/turn
Load regulation	Measured at sense terminals	-150		150	mV
Line regulation	Measured at sense terminals	-0.1		0.1	%V _{NOM}
Cross regulation	Measured at sense terminals	-0.2		0.2	%V _{NOM}
Minimum load			0		A
Output temperature drift		-0.02		0.02	%/°C
Ripple and Noise	20 MHz bandwidth, peak-peak			1	%V _{NOM}
Transient response	25% to 75% load transient, at 0.25A/μs; recovery to within 10% of V _{SET}			3	V
				100	μs
Turn on rise time	Monotonic, 10% to 90%	1.5		3.5	ms
Turn on overshoot				0.1	%V _{SET}
Turn on delay	From AC on to Power Good		600	750	ms
	From Enable to Power Good		15	20	ms
Current sharing accuracy				5	%I _{MAX}
Open sense offset	Open sense, voltage offset due to bias currents			2	%V _{NOM}
Hold-up voltage				25	V
Isolation to ground	Each terminal			250	V
Over current protection	% of rated current	105		125	%I _{RATED}
Reverse current protection	% of rated current	-6		0	%I _{RATED}
Short circuit protection (Hiccup mode)	Period		125		ms
	Duty cycle		3		%
	Voltage threshold (at sense)		3.5		V
Over voltage protection	Latching		36		V
Over temperature protection	Internally monitored, latching	115		125	°C
Sense cable protection	On positive terminal	-1		2	V
	On negative terminal	none		1	V
Power good threshold	Low threshold only		90		%V _{SET}
Output current signal	I _{SGN} = 0.6 + I _{OUT} / (I _{RTD} * 1.25)	0		110	%I _{RATED}
Current limit control	I _{LMT} = (V _{CTRL} - 0.6) * I _{RTD} * 1.25	0		110	%I _{RATED}
Remote voltage control	V _{OUT} = V _{SET} * ((1.8 - V _{CTRL}) / 0.6)	0		300	%V _{SET}
Bias supply	10 mA max	4.5	5	5.2	V
Reliability	At 40 °C, 80% load			1	FPMH
Warranty				2	Years
Wire size	Power cables	20	18	10	AWG
Weight				60	g
Size	60 mm x 35 mm x 17 mm, or, 2.36 in x 1.38 in x 0.67 in				

OUTPUT SPECIFICATIONS – MODULE D (RCA-OPD)

Parameter	Test conditions / Notes	Min	Nominal	Max	Units
Output voltage range		18	48	58	
Rated current				3.75	A
Average output power				150	W
Peak output power	Less than 5 s, 50% duty cycle			225	W
Initial voltage accuracy	Factory set units, Measured at sense terminals	-0.5		0.5	% V _{SET}
Output voltage adjustment	Manual: 11-turns potentiometer		3.6		V/turn
Load regulation	Measured at sense terminals	-300		300	mV
Line regulation	Measured at sense terminals	-0.1		0.1	%V _{NOM}
Cross regulation	Measured at sense terminals	-0.2		0.2	%V _{NOM}
Minimum load			0		A
Output temperature drift		-0.02		0.02	%/°C
Ripple and Noise	20 MHz bandwidth, peak-peak			1	%V _{NOM}
Transient response	25% to 75% load transient, at 0.25A/μs; recovery to within 10% of V _{SET}			3	V
				100	μs
Turn on rise time	Monotonic, 10% to 90%	1.5		3.5	ms
Turn on overshoot				0.1	%V _{SET}
Turn on delay	From AC on to Power Good		600	750	ms
	From Enable to Power Good		15	20	ms
Current sharing accuracy				5	%I _{MAX}
Open sense offset	Open sense, voltage offset due to bias currents			2	%V _{NOM}
Hold-up voltage				50	V
Isolation to ground	Each terminal			250	V
Over current protection	% of rated current	105		125	%I _{RATED}
Reverse current protection	% of rated current	-6		0	%I _{RATED}
Short circuit protection (Hiccup mode)	Period		125		ms
	Duty cycle		3		%
	Voltage threshold (at sense)		3.5		V
Over voltage protection	Latching		66		V
Over temperature protection	Internally monitored, latching	115		125	°C
Sense cable protection	On positive terminal	-3		3	V
	On negative terminal	none		2	V
Power good threshold	Low threshold only		90		%V _{SET}
Output current signal	$I_{SGN} = 0.6 + I_{OUT}/(I_{RTD} * 1.25)$	0		110	%I _{RATED}
Current limit control	$I_{LMT} = (V_{CTRL} - 0.6) * I_{RTD} * 1.25$	0		110	%I _{RATED}
Remote voltage control	$V_{OUT} = V_{SET} ((1.8 - V_{CTRL}) / 0.6)$	0		300	%V _{SET}
Bias supply	10 mA max	4.5	5	5.2	V
Reliability	At 40 °C, 80% load			1	FPMH
Warranty				2	Years
Wire size	Power cables	20	18	10	AWG
Weight				60	g
Size	60 mm x 35 mm x 17 mm, or, 2.36 in x 1.38 in x 0.67 in				

OUTPUT SPECIFICATIONS – MODULE W (RCA-OPW)

Parameter	Test conditions / Notes	Min	Nominal	Max	Units
Voltage range	Each channel	3.3	12	15	V
Rated current	Each channel			5.0	A
Rated power	Each channel			75	W
Initial voltage accuracy	Factory set units	-1		1	% V _{SET}
Voltage adjustment	Manual: 11-turns potentiometer		1.1		V/turn
Load regulation	Measured at sense terminals	-50		50	mV
Line regulation	Measured at sense terminals	-0.1		0.1	%V _{NOM}
Cross regulation	Measured at sense terminals	-0.2		0.2	%V _{NOM}
Minimum load			0		A
Temperature drift		-0.02		0.02	%/°C
Ripple and Noise	20 MHz bandwidth, peak-to-peak V _{SET} : 12 V			2	%V _{NOM}
Transient response	25% to 75% load transient, at 1A/μs, recovery to within 10% of V _{SET}			1	V
Turn on rise time	Monotonic, 10 to 90 %	4.5	5.5	6.5	ms
Turn on overshoot				0.1	%V _{SET}
Turn on delay	From AC on (120 V _{AC}) to Power Good From Enable to Power Good	250 15		350 25	ms
Hold-up voltage				12	V
V1/V2 Isolation to ground	Each terminal			250	V
Isolation V1 to V2	Each terminal			250	V
Over current protection	Hiccup mode	105		125	%I _{RATED}
Reverse current protection	None				%I _{RATED}
Short circuit protection	Hiccup period Hiccup duty cycle		50 25		ms %
Over voltage protection	Latching	19	20	21	V
Over temperature protection	Internally monitored, latching	115		125	°C
Power good threshold	High threshold Low threshold only	90 88	94 92	98 95	%V _{SET}
Reliability	At 40 °C, 80% duty cycle, 100% load Telcordia SR-332 Issue 2			1	FPMH
Warranty				2	Years
Wire size	Power cables	20	18	10	AWG
Size and weight	(27.5 x 65.9 x 15.7) mm; (1.08 x 2.59 x 0.62) in; 60 g 2.1 oz				

OUTPUT SPECIFICATIONS – MODULE Z (RCA-OPZ)

Parameter	Test conditions / Notes	Min	Nominal	Max	Units
Voltage range	Each channel	15	24	38	V
Rated current	Each channel at 24V output. De-rating applies over 24V output			3.125	A
Rated power	Each channel			75	W
Initial voltage accuracy	Factory set units	-1		1	% V _{SET}
Voltage adjustment	Manual: 11-turns potentiometer		2.2		V/turn
Load regulation	Measured at sense terminals	-50		50	mV
Line regulation	Measured at sense terminals	-0.1		0.1	%V _{NOM}
Cross regulation	Measured at sense terminals	-0.2		0.2	%V _{NOM}
Minimum load			0		A
Temperature drift		-0.02		0.02	%/°C
Ripple and Noise	20 MHz bandwidth, peak-to-peak V _{SET} : 24 V			2	%V _{NOM}
Transient response	25% to 75% load transient, at 1A/μs, recovery to within 10% of V _{SET}			1 100	V μs
Turn on rise time	Monotonic, 10 to 90 %	1.5		3.5	ms
Turn on overshoot				0.1	%V _{SET}
Turn on delay	From AC On (120 V _{AC}) to Power Good From Enable to Power Good	250 15		350 25	ms
Hold-up voltage				24	V
V1/V2 Isolation to ground	Each terminal			250	V
Isolation V1 to V2	Each terminal			250	V
Over current protection	Hiccup mode	105		125	%I _{RATED}
Reverse current protection	None				%I _{RATED}
Short circuit protection	Hiccup period Hiccup duty cycle		50 25		ms %
Over voltage protection	Latching	44		46	V
Over temperature protection	Internally monitored, latching	115		125	°C
Power good threshold	High threshold Low threshold only	90 88	94 92	98 95	%V _{SET}
Reliability	At 40 °C, 80% duty cycle, 100% load Telcordia SR-332 Issue 2			1	FPMH
Warranty				2	Years
Wire size	Power cables	20	18	10	AWG
Size and weight	(27.5 x 65.9 x 15.7) mm; (1.08 x 2.59 x 0.62) in; 60 g 2.1 oz				

Specifications appearing in EFORE's catalogues and brochures as well as any oral statements are not binding. All descriptions, drawings and other particulars (including dimensions, materials and performance data) given by EFORE are as accurate as possible but, being given for general information, and are not binding on EFORE. EFORE makes thus no representation or warranty as to the accuracy of such material. We assume no liability other than as agreed in the terms of the individual contracts and we reserve the right to make technical modifications in the course of our product development. Our product information solely describes our goods and services and is in no way to be construed or interpreted as a quality or condition guarantee. The aforesaid shall not relieve the customer of its obligation to verify the suitability of our Products for the use or application intended by the purchaser. Customers are responsible for their products and applications. EFORE assumes no liability from the use of its products outside of specifications. No license is granted to any intellectual property rights by this document.