



**ATTENTION**  
OBSERVE PRECAUTIONS  
FOR HANDLING  
ELECTROSTATIC  
DISCHARGE  
SENSITIVE  
DEVICES

### Features

- 3.2mmX1.6mm SMT LED, 1.8mm THICKNESS.
- LOW POWER CONSUMPTION.
- WIDE VIEWING ANGLE.
- IDEAL FOR BACKLIGHT AND INDICATOR.
- VARIOUS COLORS AND LENS TYPES AVAILABLE.
- PACKAGE: 2000PCS / REEL .
- MOISTURE SENSITIVITY LEVEL : LEVEL 3.
- RoHS COMPLIANT.

### Description

The Blue source color devices are made with AlInGaN on Sapphire Light Emitting Diode.  
Static electricity and surge damage the LEDs.  
It is recommended to use a wrist band or anti-electrostatic glove when handling the LEDs.  
All devices, equipment and machinery must be electrically grounded.

### Package Dimensions

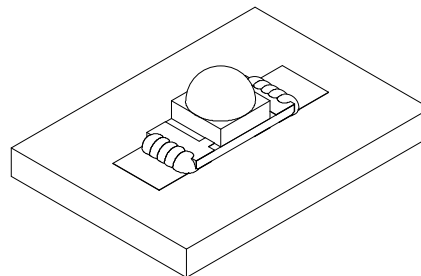
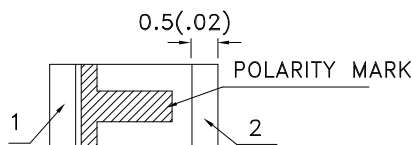
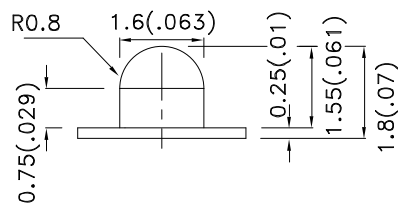
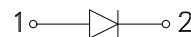
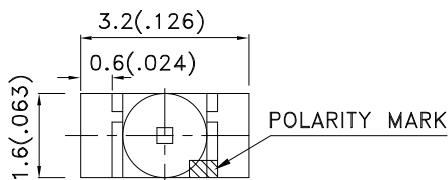

Notes:

1. All dimensions are in millimeters (inches).
2. Tolerance is  $\pm 0.2(0.008)$  unless otherwise noted.
3. Specifications are subject to change without notice.
4. The device has a single mounting surface. The device must be mounted according to the specifications.



## Selection Guide

Part No.	Dice	Lens Type	Iv (mcd) [2] @ 20mA		Viewing Angle [1]
			Min.	Typ.	2θ1/2
KPTD-3216QBC-D	Blue (AlInGaN)	WATER CLEAR	280	500	40°

Notes:

1. θ1/2 is the angle from optical centerline where the luminous intensity is 1/2 the optical centerline value.
2. Luminous intensity/ luminous Flux: +/-15%.

## Electrical / Optical Characteristics at TA=25°C

Symbol	Parameter	Device	Typ.	Max.	Units	Test Conditions
$\lambda_{peak}$	Peak Wavelength	Blue	468		nm	I <sub>F</sub> =20mA
$\lambda_D$ [1]	Dominant Wavelength	Blue	470		nm	I <sub>F</sub> =20mA
$\Delta\lambda_{1/2}$	Spectral Line Half-width	Blue	25		nm	I <sub>F</sub> =20mA
C	Capacitance	Blue	100		pF	V <sub>F</sub> =0V;f=1MHz
V <sub>F</sub> [2]	Forward Voltage	Blue	3.3	4	V	I <sub>F</sub> =20mA
I <sub>R</sub>	Reverse Current	Blue		10	uA	V <sub>R</sub> =5V

Notes:

- 1.Wavelength: +/-1nm.
2. Forward Voltage: +/-0.1V.

## Absolute Maximum Ratings at TA=25°C

Parameter	Blue	Units
Power dissipation	120	mW
DC Forward Current	30	mA
Peak Forward Current [1]	150	mA
Reverse Voltage	5	V
Operating Temperature	-40°C To +85°C	
Storage Temperature	-40°C To +85°C	

Note:

1. 1/10 Duty Cycle, 0.1ms Pulse Width.

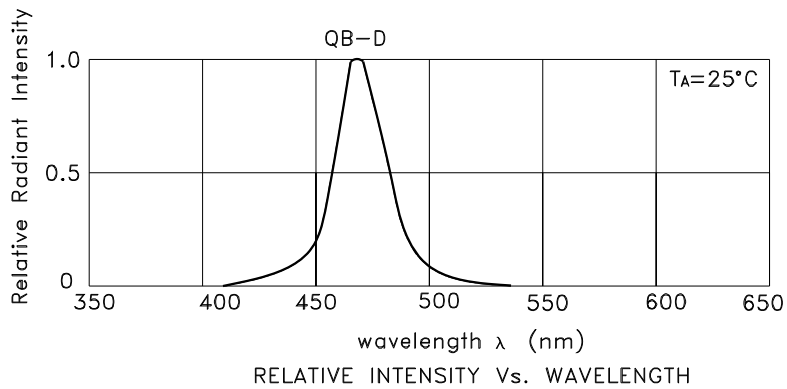

**Blue**

**KPTD-3216QBC-D**

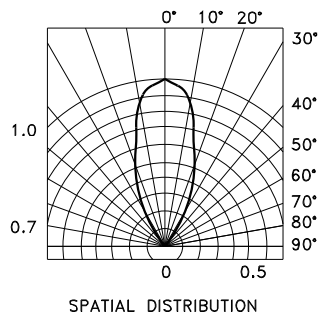
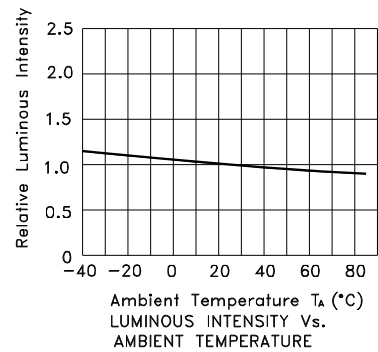
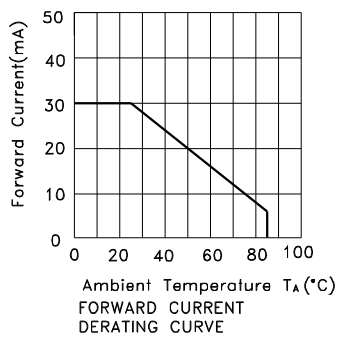
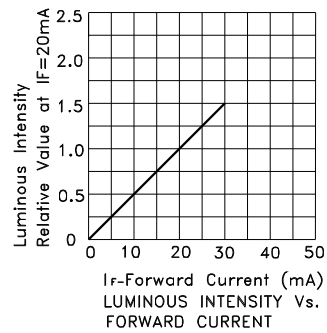
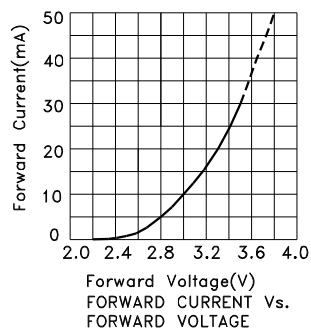

## KPTD-3216QBC-D

Reflow Soldering Profile For Lead-free SMT Process.



**NOTES:**

1. We recommend the reflow temperature 245°C(+/-5°C). The maximum soldering temperature should be limited to 260°C.
2. Don't cause stress to the epoxy resin while it is exposed to high temperature.
3. Number of reflow process shall be 2 times or less.

**Recommended Soldering Pattern**  
(Units : mm; Tolerance: ± 0.1)

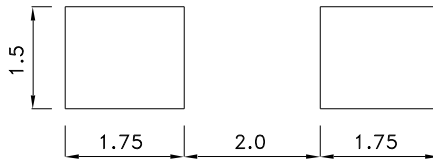

**Tape Specifications**  
(Units : mm)

